

MACOMTM

Partners from RF to Light



**SPICE Model
MA4P303-134**

Nov 11, 2022



Contents

- **Test Fixtures**
- **Bond Wire**
- **Diode**
- **Results**
 - IV Curve
 - Series 100 mA
 - Series -40 V
 - Shunt 100 mA
 - Shunt -40 V
- **Disclosure**

Test Fixtures

- 10 mils Rogers RO3010 with 1/2 oz copper
- S-parameters measured with port extensions such that the reference planes are set to the dash lines on the input and output as shown below

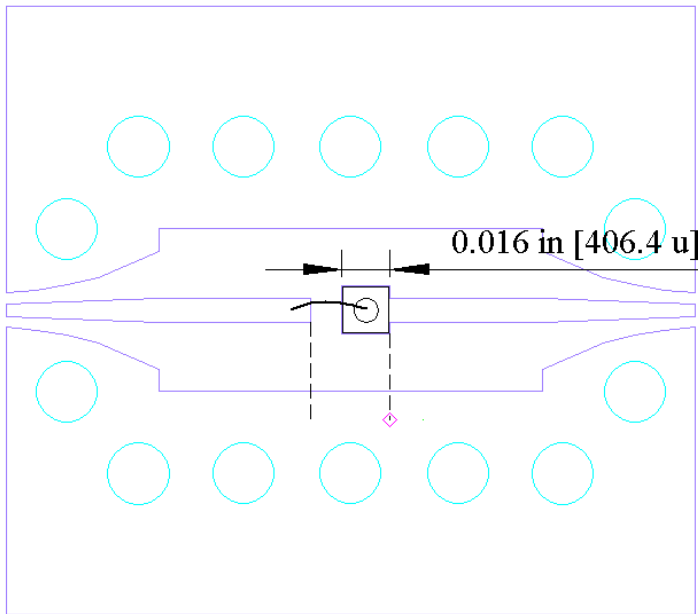

Series

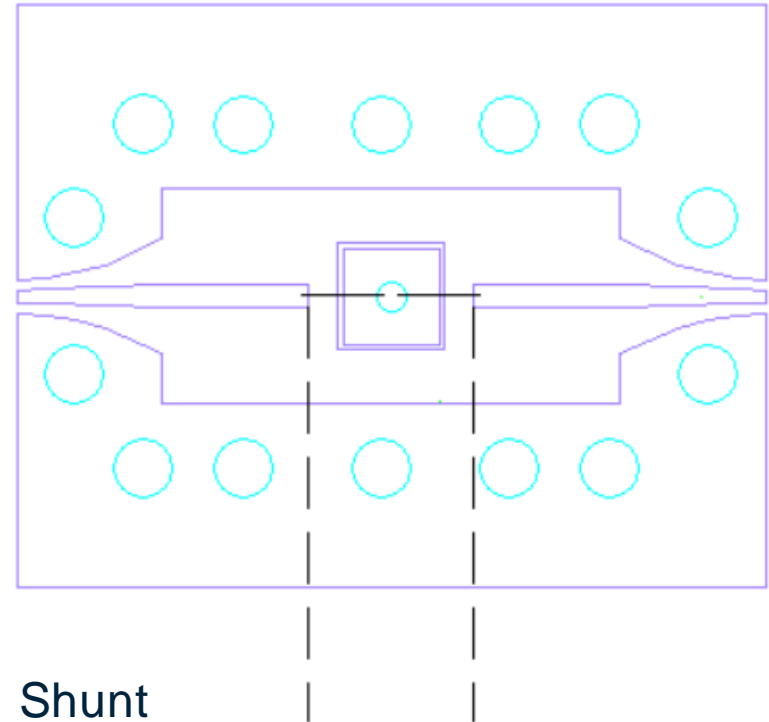

Shunt

Series Test Fixture Model

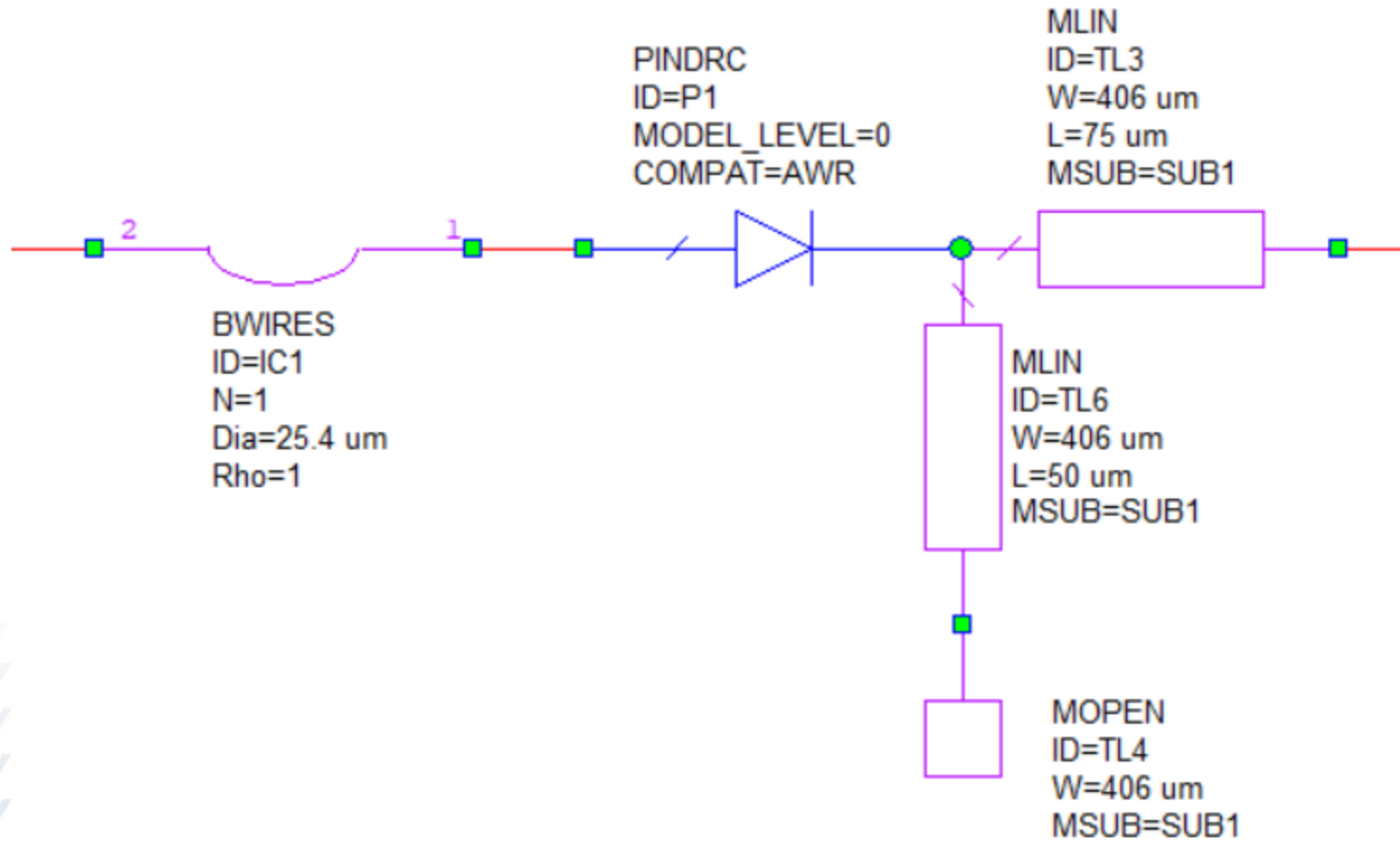

Shunt Test Fixture Model

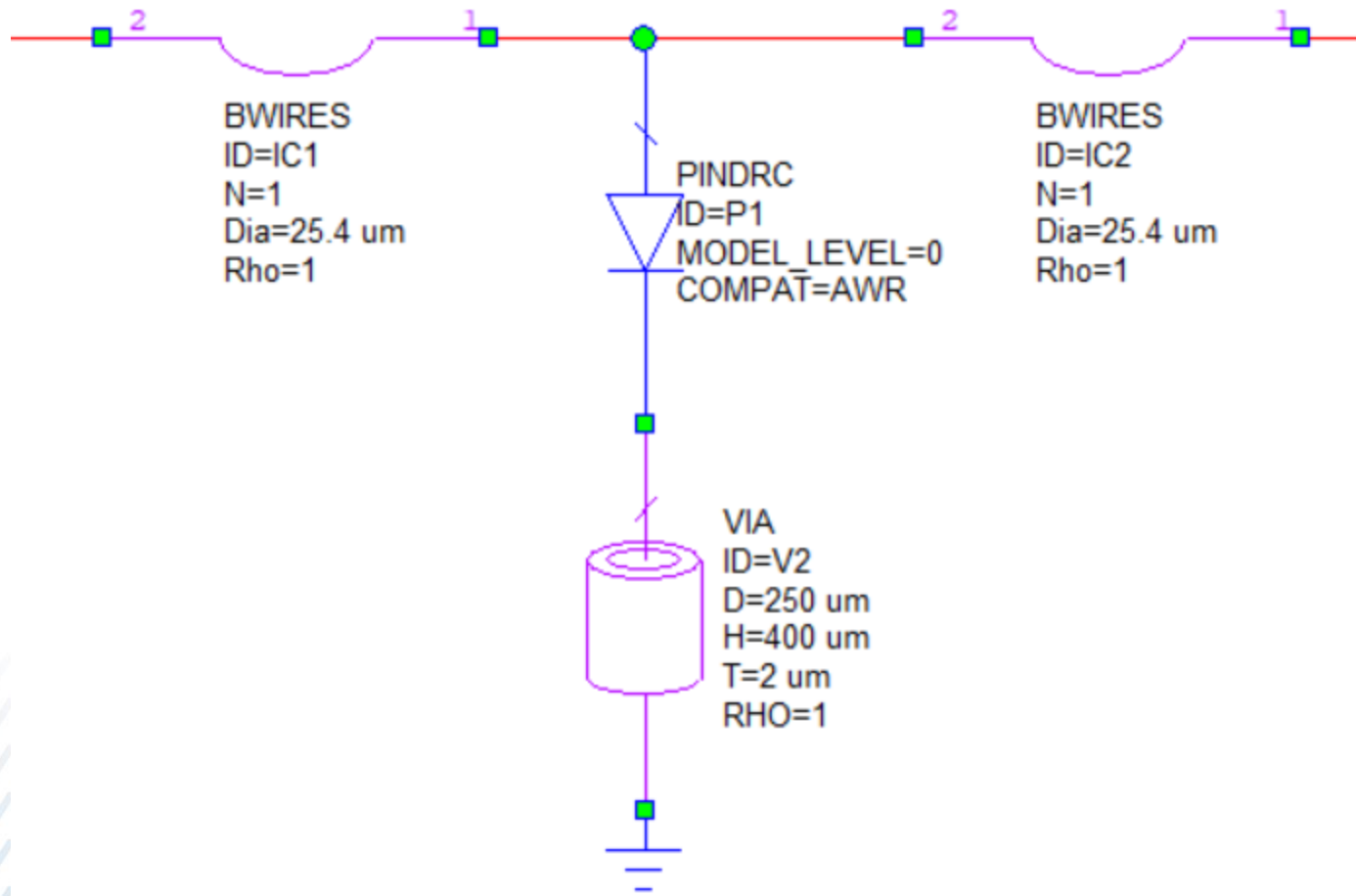

Bond Wire

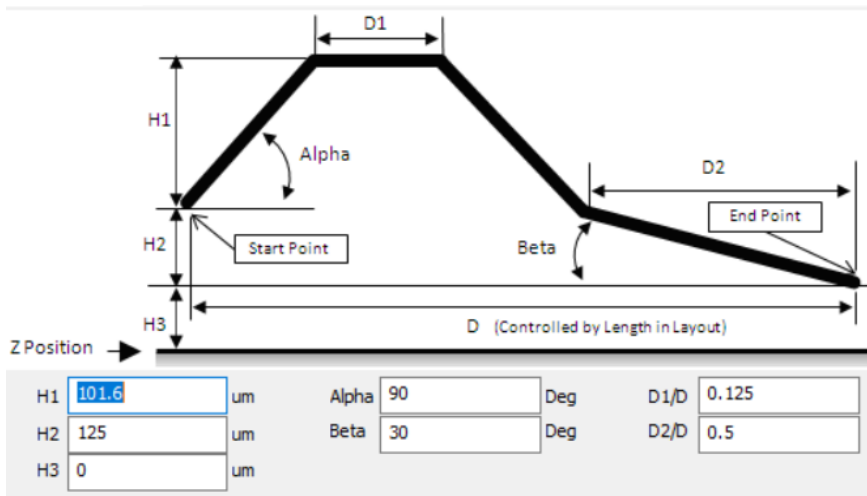

Element Options: BWIRES - Bond wire model (EIA/JEDEC Standard No. 59)

Bondwire Profile						
Parameters						
Name	Value	Unit	Tune	Optimize	Constrain	Lower
ID	IC1					
N	1					
Dia	25.4	um	<input type="checkbox"/>	<input type="checkbox"/>	<input type="checkbox"/>	
Rho	1		<input type="checkbox"/>	<input type="checkbox"/>	<input type="checkbox"/>	
WModel	4 segments		<input type="checkbox"/>	<input type="checkbox"/>	<input type="checkbox"/>	
Alpha	90	Deg	<input type="checkbox"/>	<input type="checkbox"/>	<input type="checkbox"/>	
Beta	30	Deg	<input type="checkbox"/>	<input type="checkbox"/>	<input type="checkbox"/>	
H1	101.6	um	<input type="checkbox"/>	<input type="checkbox"/>	<input type="checkbox"/>	
H2	125	um	<input type="checkbox"/>	<input type="checkbox"/>	<input type="checkbox"/>	
H3	0	um	<input type="checkbox"/>	<input type="checkbox"/>	<input type="checkbox"/>	
D1_Ratio	0.125		<input type="checkbox"/>	<input type="checkbox"/>	<input type="checkbox"/>	
D2_Ratio	0.5		<input type="checkbox"/>	<input type="checkbox"/>	<input type="checkbox"/>	
P0	{0,0}	um				
P1	{BW_len,0}	um				
IndModel	RLC		<input type="checkbox"/>	<input type="checkbox"/>	<input type="checkbox"/>	

BW_len = 770

Robert Caverly PIN Diode Model

PINDRC
 ID=P1
 MODEL_LEVEL=0
 COMPAT=AWR

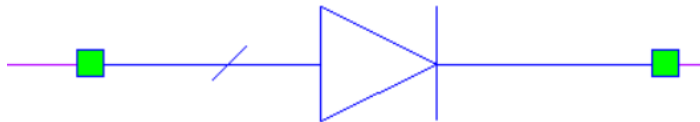

Name	Value	Unit
ID	P1	
IS	Is	mA
IKNEE	Iknee	mA
N	Npin	
RLIM	Rs	Ohm
REPI	Repi	Ohm
CJ	Cj	pF
CPKG	Cpkg	pF
TAU	LT	ns
W	W	
B	3	
LBOND	Lpkg	nH
TNOM	26.85	DegC
TEMP	26.85	DegC
AREA	1	
NFLAG	Noise Off	

Is=5e-07
 Iknee=3
 Npin=1
 Repi=1000
 LT=310
 W=19
 Cj=0.11
 Rs=0.19
 Cpkg=0.0
 Lpkg=0.0

IV Curve

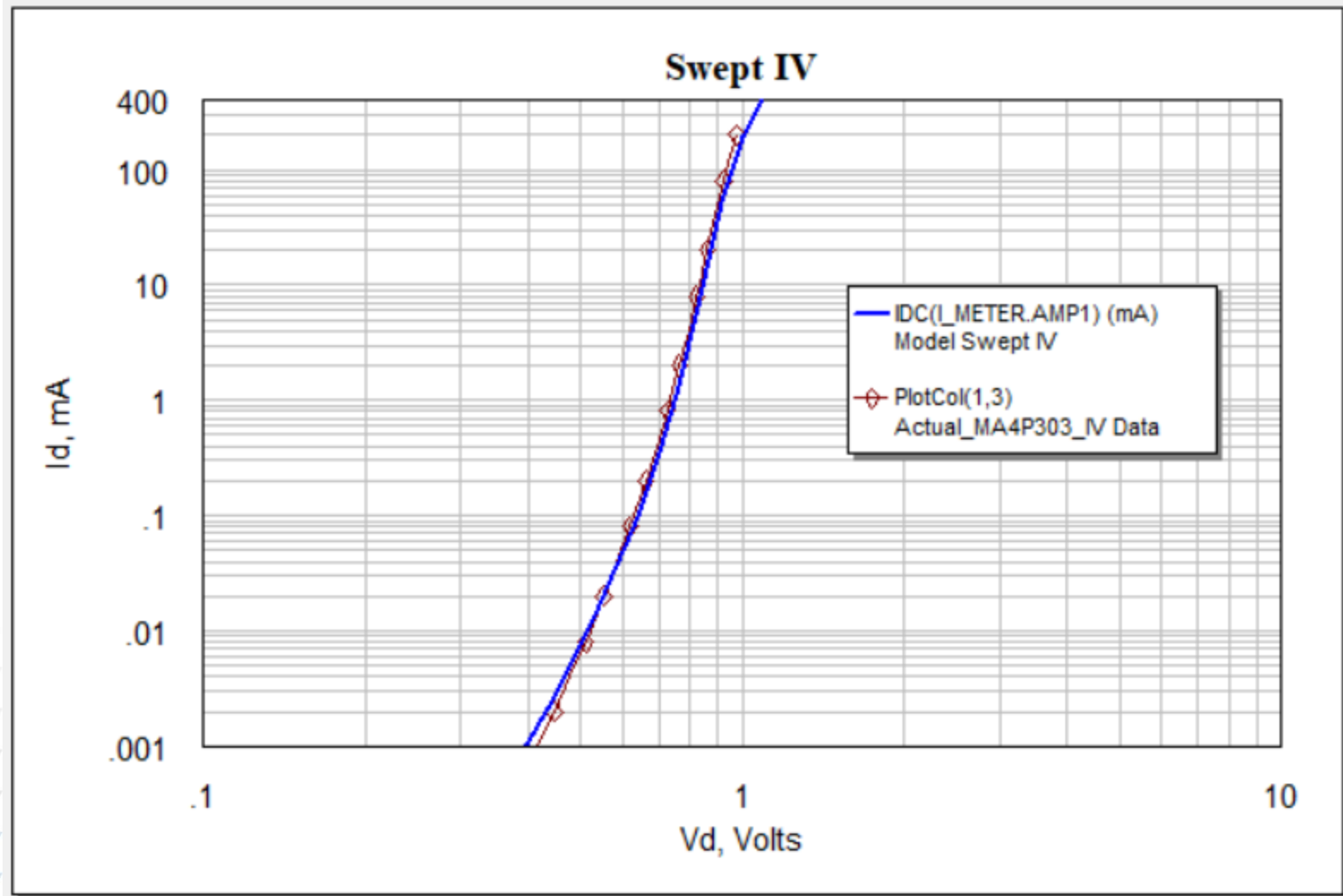

Series 100 mA

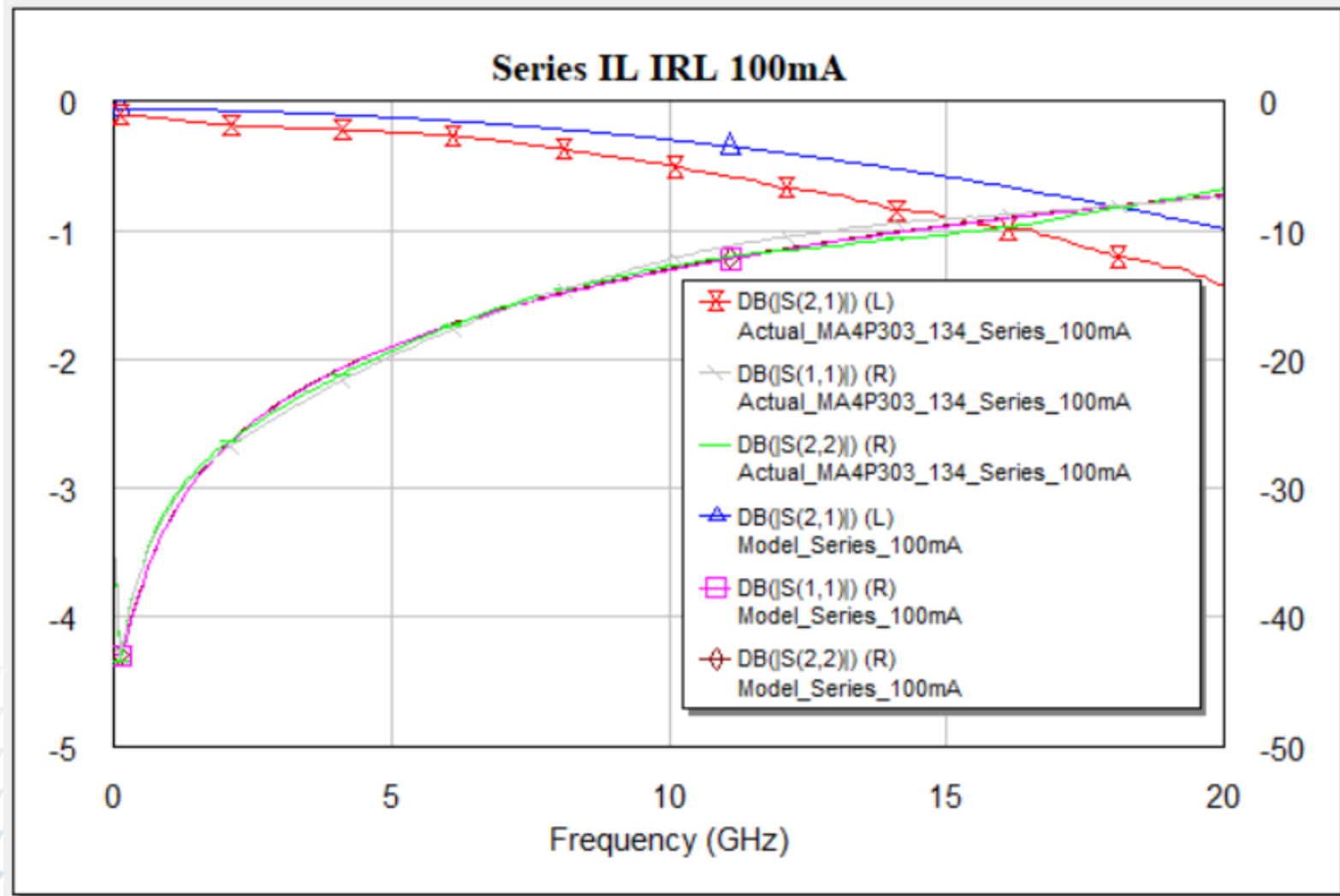

Series 100 mA

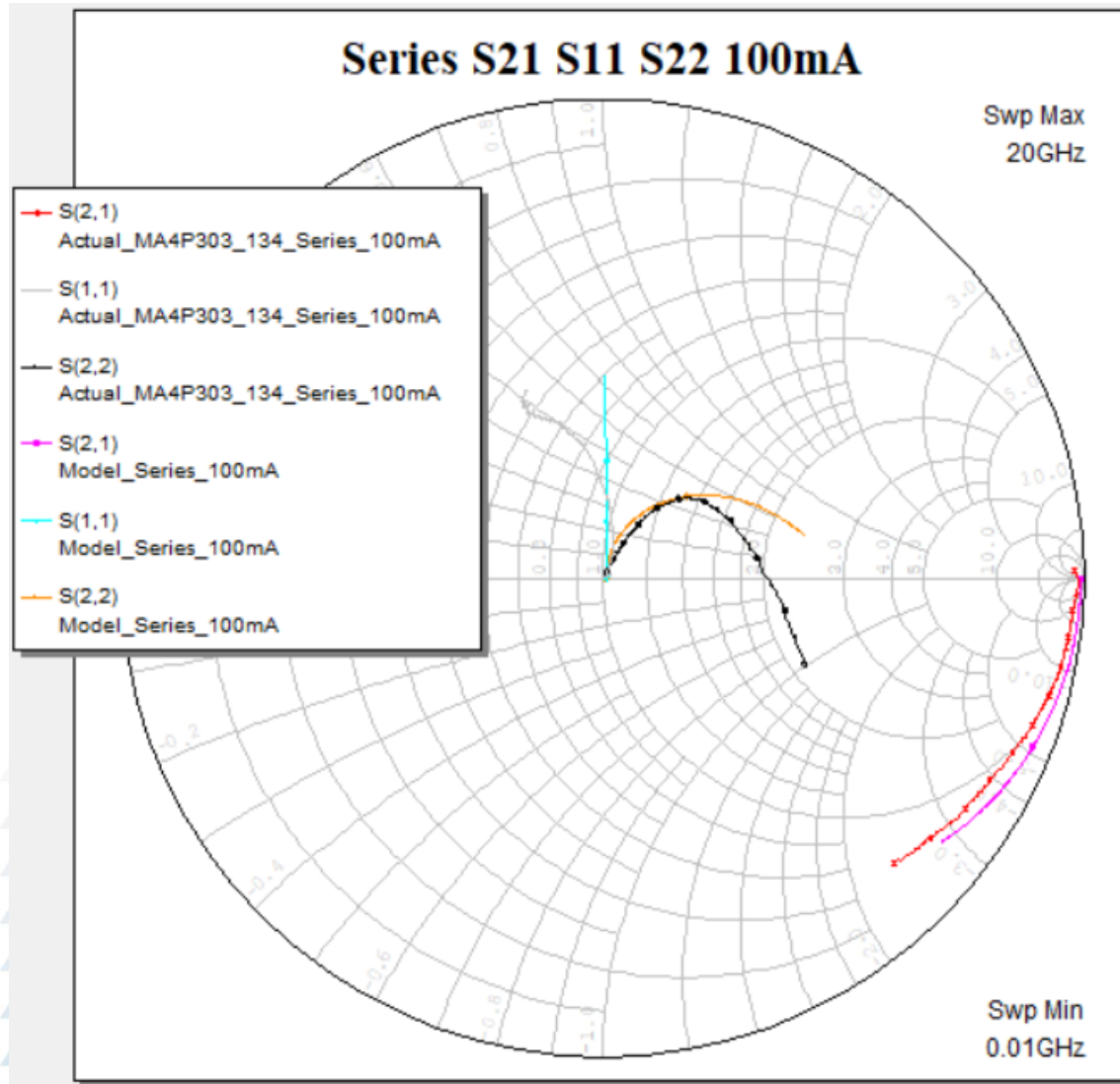

Series -40 V

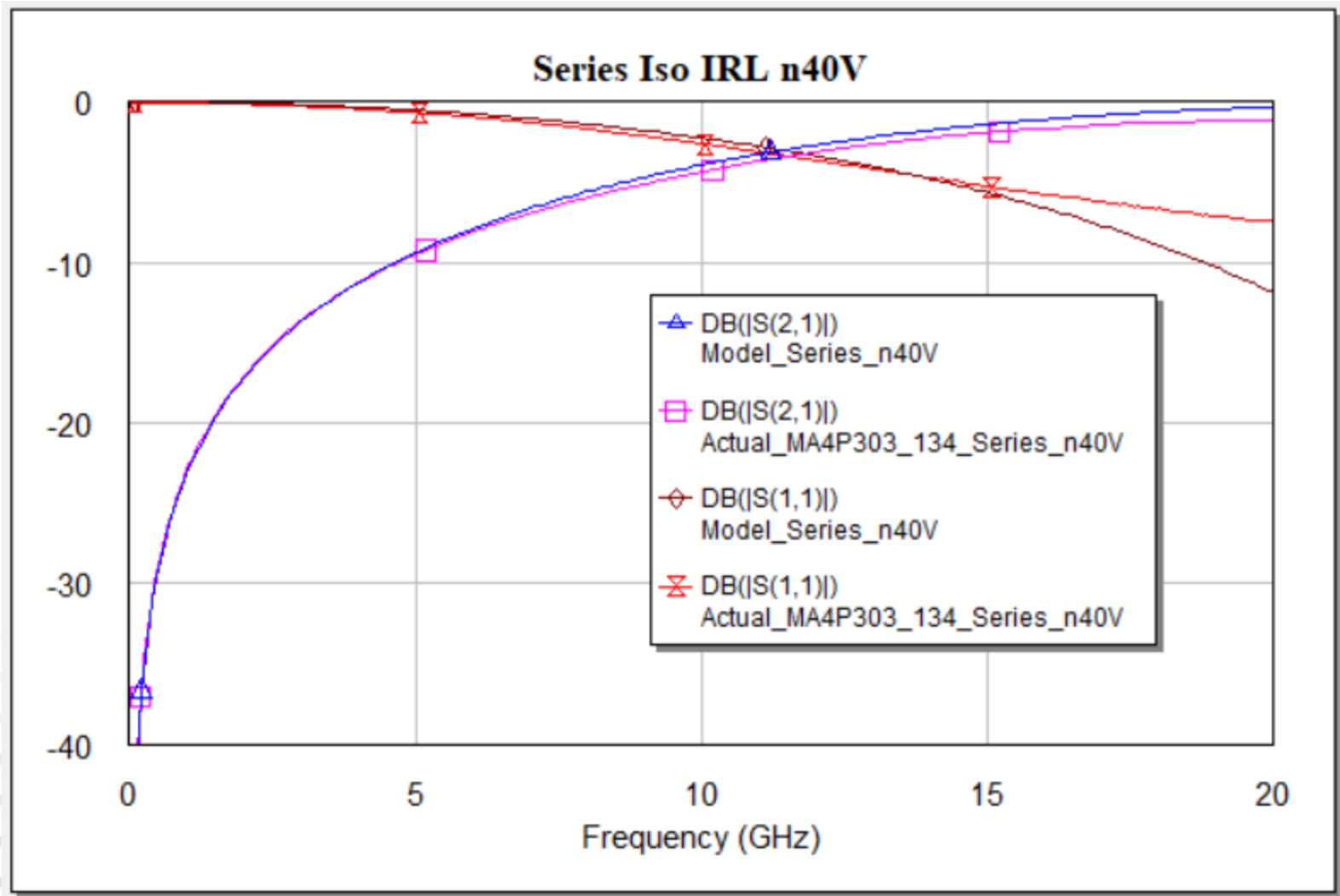

Series -40 V

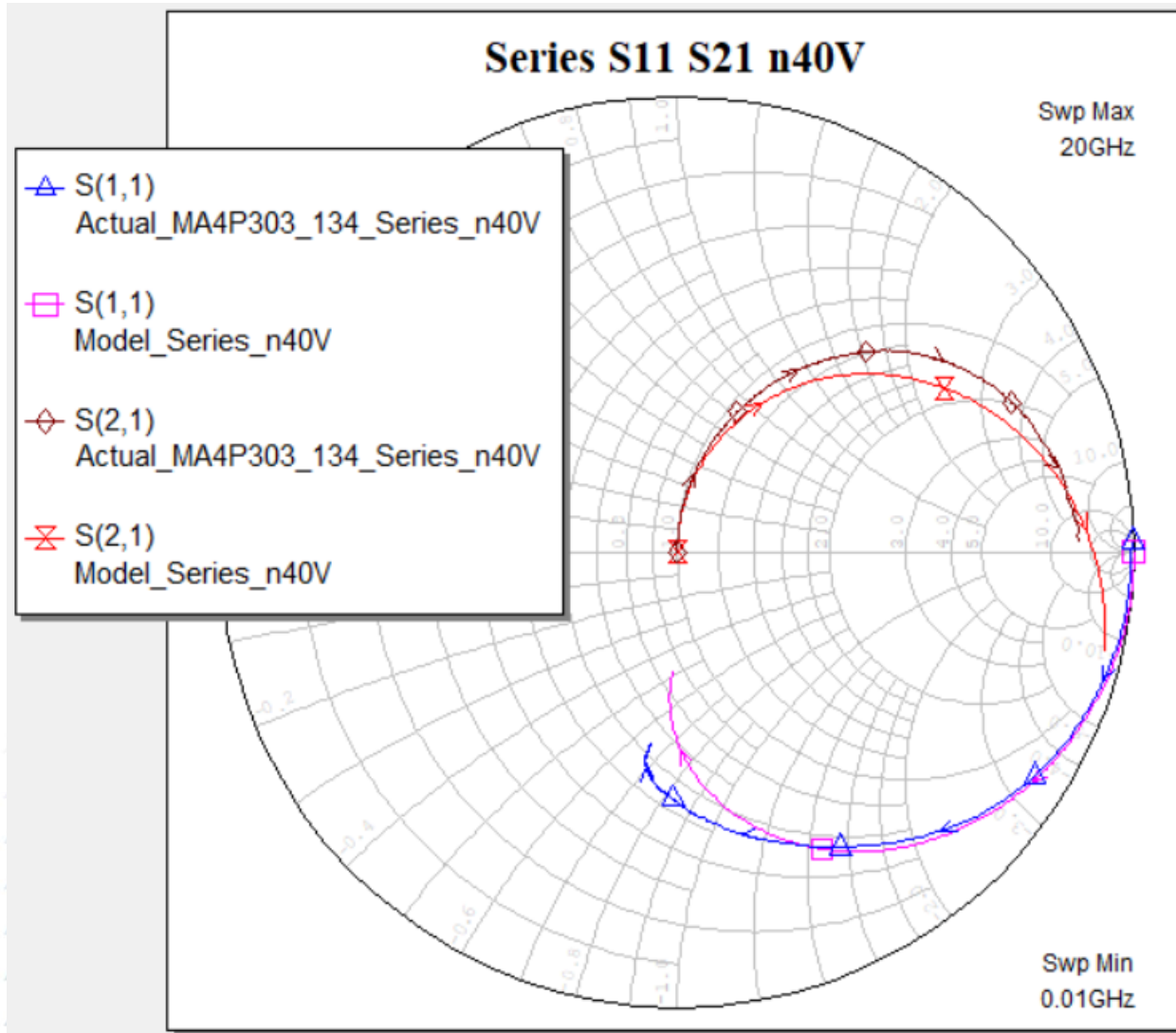

Shunt 100 mA

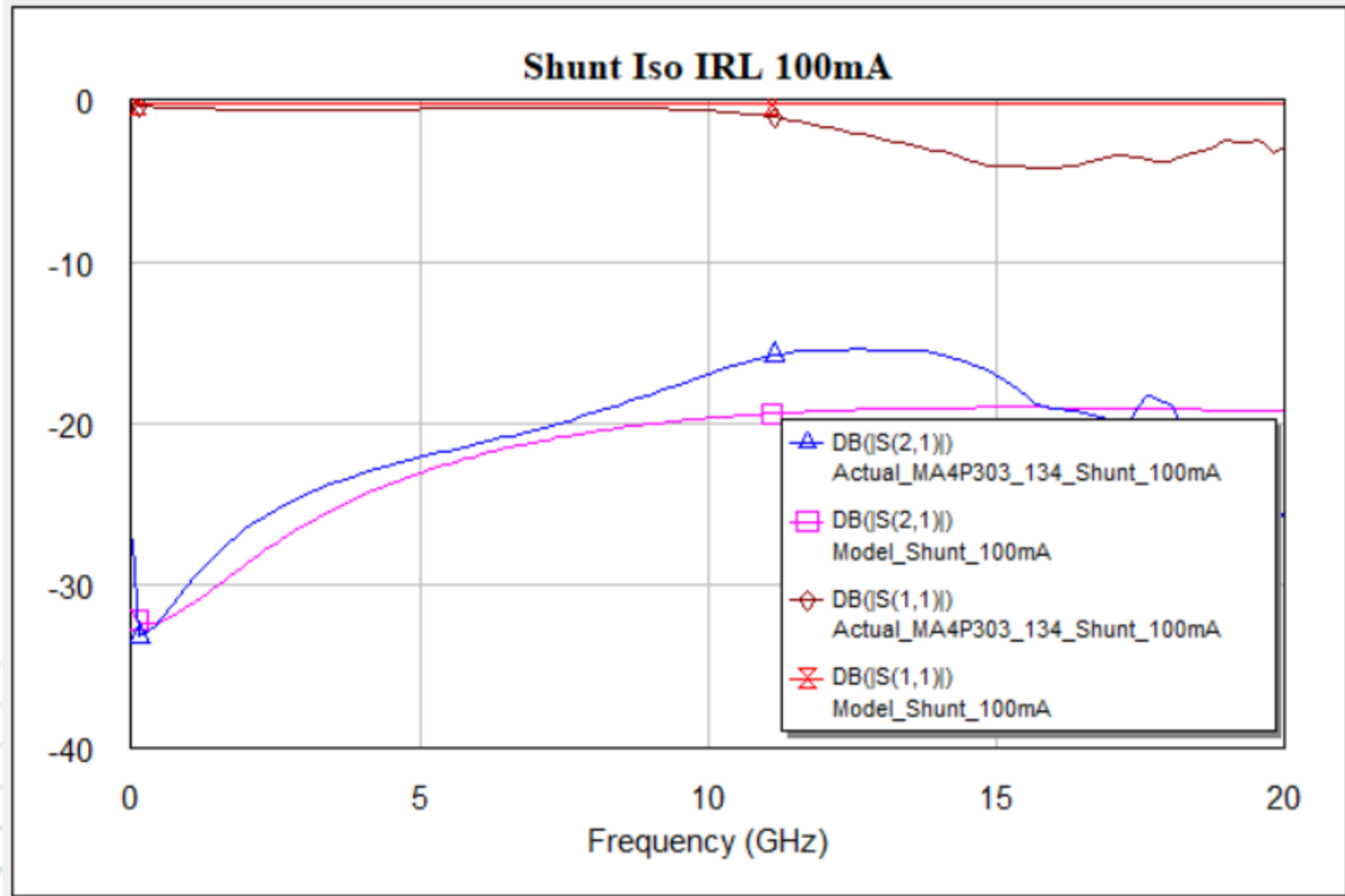

Shunt 100 mA

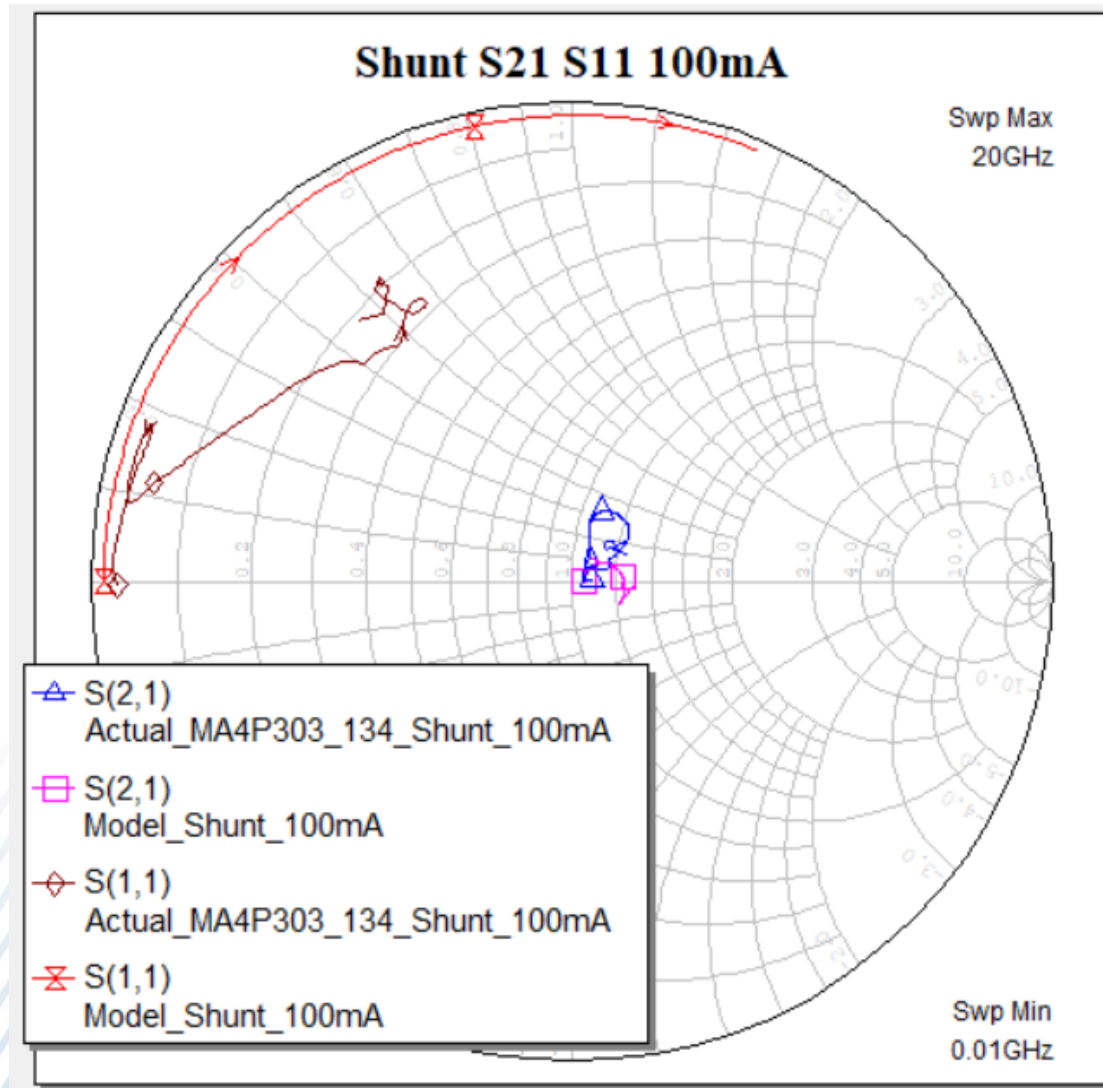

Shunt -40 V

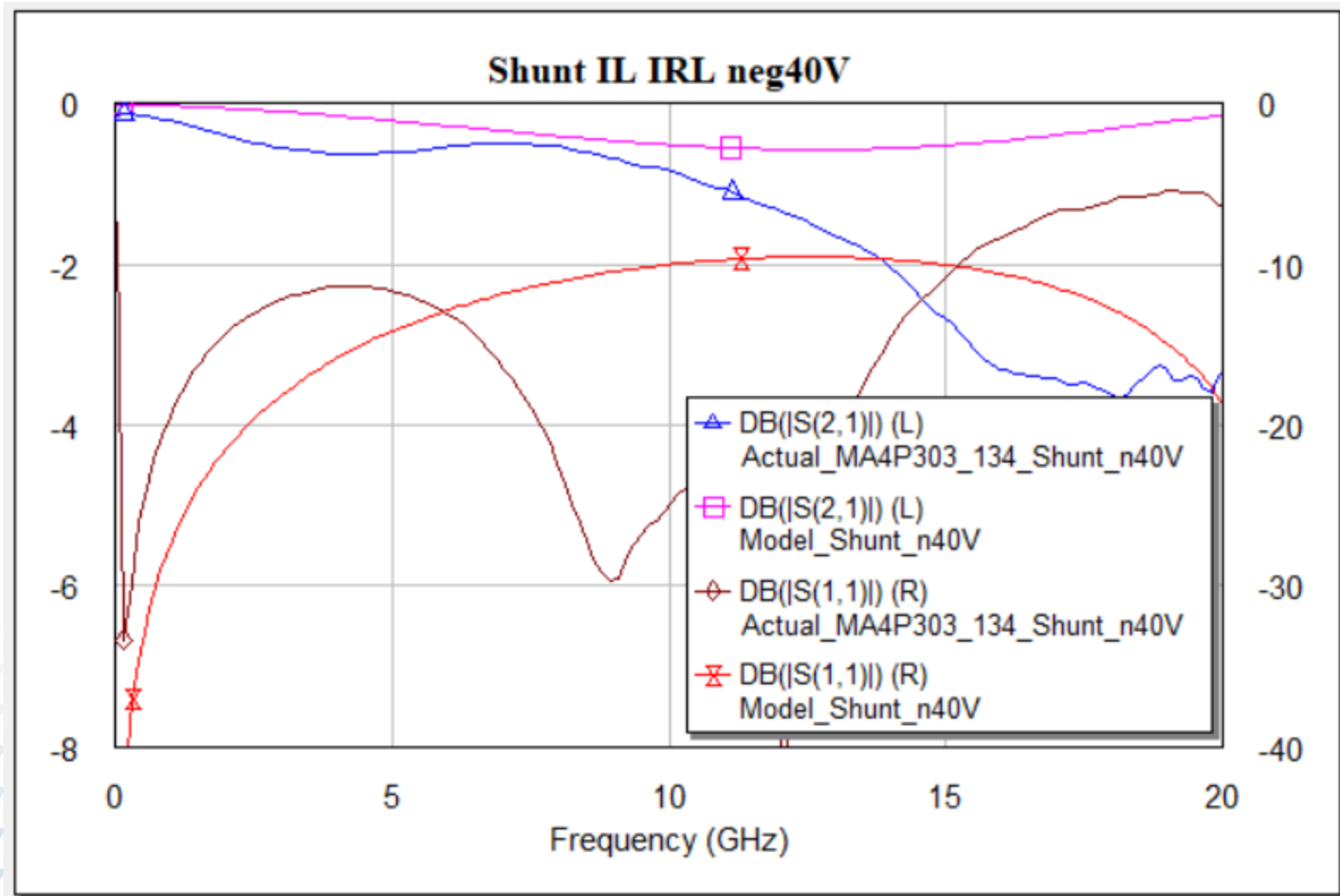

Shunt -40 V

Believe model over measurement

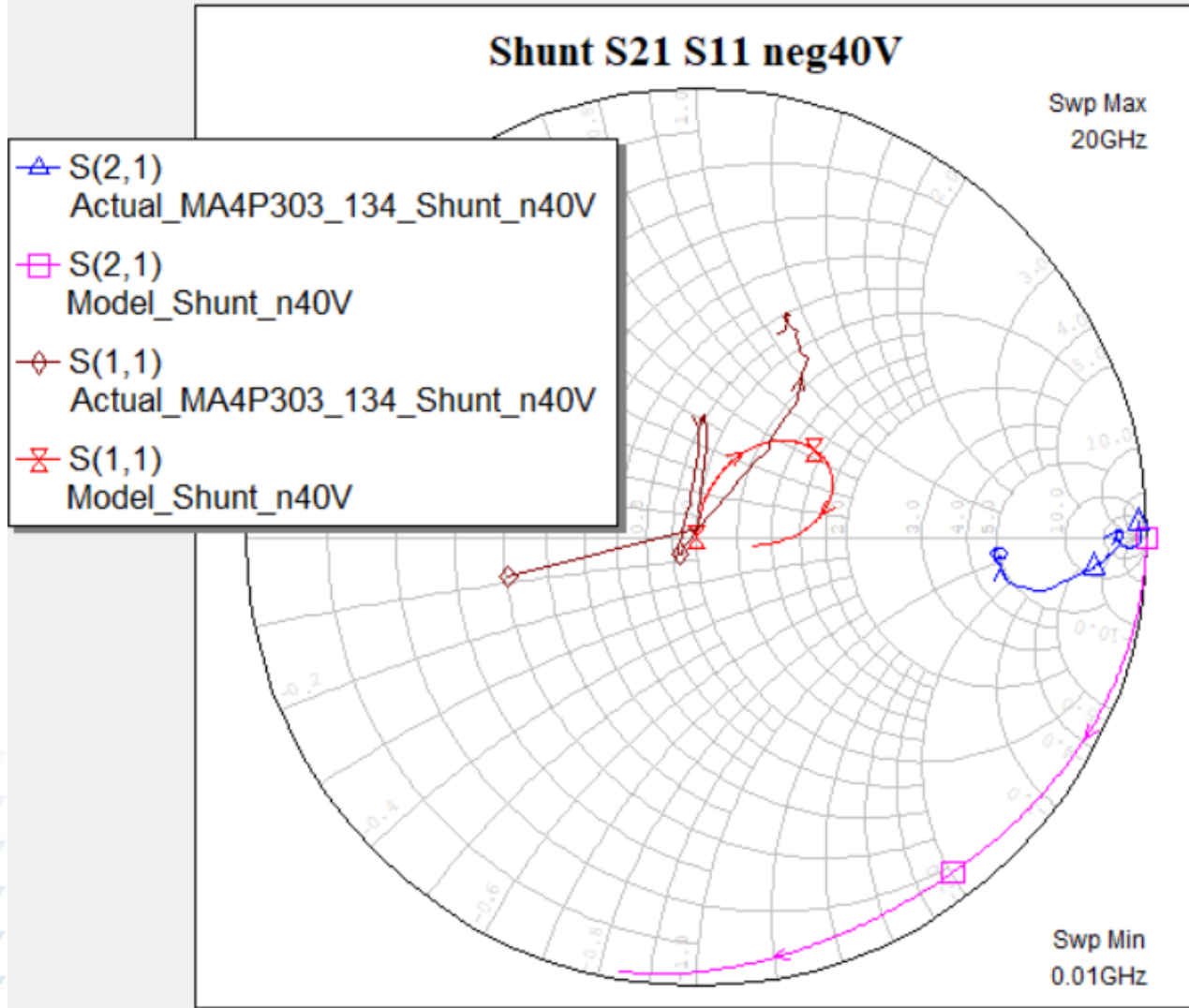

These models are furnished on an "as is" basis without warranty of any kind. MACOM reserves the right to make changes to any model without notice. Although the use of models can be a useful tool in evaluating devices for applications, they do not exactly model all device characteristics under all conditions.